

LA BUVETTE®

Parc d'activités Ardennes Émeraude
Rue Maurice Perin - CS 50749 Tournes
F-08013 CHARLEVILLE-MEZIERES Cedex FRANCE
TEL : 03.24.52.37.20 - FAX : 03.24.52.37.24
Int. : 033.324.52.37.23 Int. : 033.324.52.37.24
S.A.V. : 03.24.52.37.27 - FAX : 03.24.52.37.24
Internet : www.labuvette.com
e-mail : commercial@labuvette.com
sav@labuvette.com

2285

Instruction de montage Assembly instructions Montage anweisungen

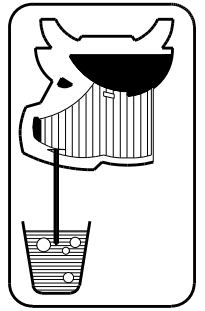

SOLAR FLOW STORAGE 12V

Notice à conserver

Please keep the instructions for future reference

Bewahren Sie diese Anweisungen bitte als zukünftige referenz auf.

ou
or
oder

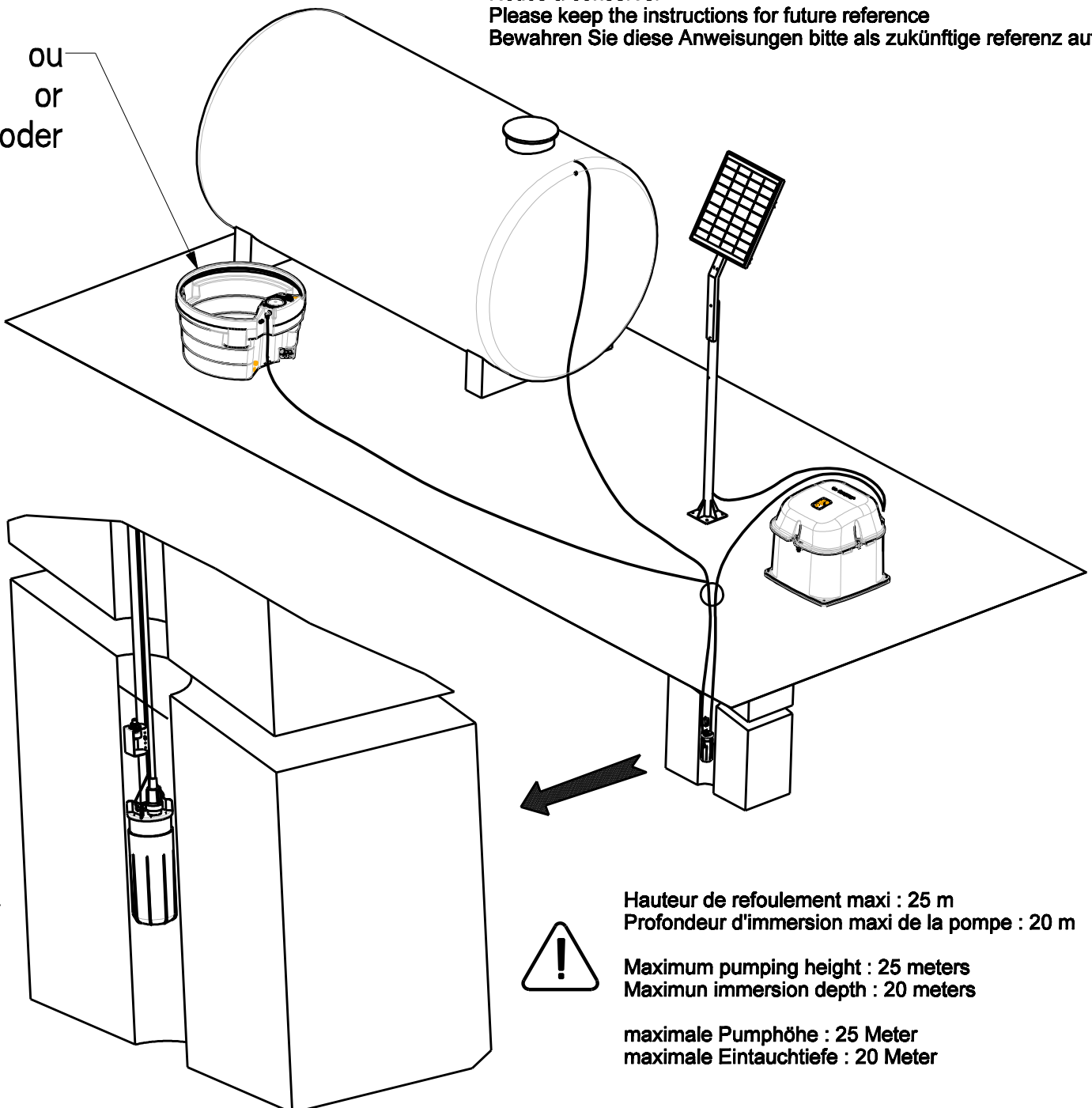

Hauteur de refoulement maxi : 25 m
Profondeur d'immersion maxi de la pompe : 20 m



Maximum pumping height : 25 meters
Maximum immersion depth : 20 meters

maximale Pumphöhe : 25 Meter
maximale Eintauchtiefe : 20 Meter

N° 4690345 11/2022



A LIRE AVANT TOUTE OPERATION

HORS SITE

Avant de déconnecter la batterie pour le stockage hivernal, il faut que la batterie soit à son maximum de charge.

Il est préférable de stocker la batterie dans un endroit sec et tempéré.

Il est possible de maintenir un état de charge optimum avec un chargeur de batterie au plomb adapté (nous contacter).

SUR SITE

Si la batterie reste branchée sur site, interdire l'utilisation de l'abreuvoir pendant la période hivernale.

En début de saison, il faut compléter la charge via les panneaux solaires durant une période de 15 jours, avant l'arrivée des animaux.

Il est vivement déconseillé d'associer des batteries de conception différente et / ou de charge différente... (nous contacter).

LA BUVETTE décline toute responsabilité du bon fonctionnement pour des systèmes n'utilisant pas les batteries préconisées : 12 Volt, 120Ah, étanches.

Le montage est conseillé par temps calme. Couvrir le panneau solaire lors des branchements.



READ BEFORE HANDLING THE BATTERY

OFF SITE

The battery must be fully charged before it can be disconnected for winter storage.

A dry and warm place is recommended for battery storage.

You can keep the battery at full charge with a suitable lead-acid battery charger (contact us for further details).

ON SITE

If the battery is permanently connected on site, make sure the drinker is never used during the wintertime.

At the start of the spring season, allow the solar panels to recharge the battery for 15 days before the animals arrive.

We strongly discourage you from using batteries with a different design and / or charge. (Contact us for further details.)

LA BUVETTE is not liable for poor operation or malfunction of systems owing to the use of other than the recommended battery types:
12 Volt, 120 Ah, watertight.

Connect the batteries in good weather conditions. Cover the solar panel during connection.

D**VOR DER HANDHABUNG MIT DER BATTERIE BITTE LESEN****EXTERN**

Die Batterie muss vollständig aufgeladen sein, bevor sie abgeklemmt und den Winter über gelagert werden kann.

Die Batterie sollte an einem warmen und trockenen Ort gelagert werden.

Mit einem geeigneten Bleiakku-Ladegerät bleibt die Batterie vollständig aufgeladen (wenden Sie sich für weitere Details bitte direkt an uns).

AM STANDORT

Wenn die Batterie am Standort dauerhaft angeschlossen ist, vergewissern Sie sich bitte, dass die Tränke während der Winterzeit nicht verwendet wird.

Zu Beginn der Frühlingssaison lassen Sie die Batterie 15 Tage lang durch die Solarmodule wieder aufladen, bevor die Tiere zurück kommen.





Wir möchten dringend davon abraten, Batterien mit einem anderen Design und / oder einer anderen Ladung zu verwenden.
(Kontaktieren Sie uns für weitere Details.)

LA BUVETTE übernimmt keine Haftung für Ausfälle oder Fehlfunktionen der Systeme, die auf die Verwendung anderer als die empfohlenen Batteriearten zurückzuführen sind. 12 Volt, 120 A, wasserdicht.

Schließen Sie die Batterien bei guter Witterung an. Das Solarmodul beim Anschließen bedecken.

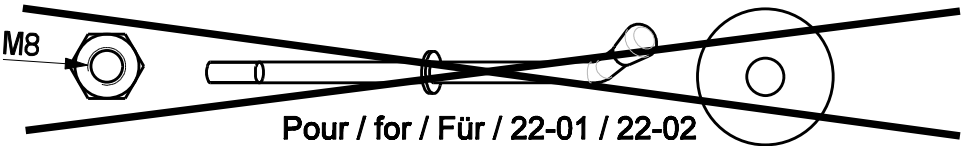
Sachet / sachet / Säckchen

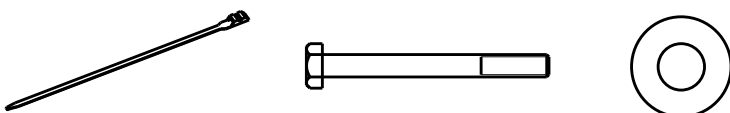
A

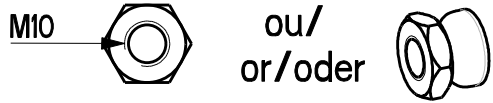
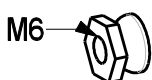
 <p style="text-align: center;">Pour / for / Für / 22-01 / 22-02</p>	x 1
	x 1
	x 2
	x 6
 <p style="text-align: center;">ou/ or/oder</p>	x 2
 <p style="text-align: center;">M6</p>	x 4

Sachet / sachet / Säckchen

F

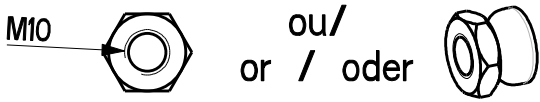
	x 4
 <p style="text-align: center;">ou/ or / oder</p>	x 4

-Si vous comptez déplacer la SOLAR FLOW, préférez les écrous standard aux écrous inviolables (facilité de montage).

-If you are likely to change the place of the SOLAR-FLOW, please prefer the use of standard nuts instead of inviolable nuts (easiness of mounting).

-Wenn Sie vorhaben, die SOLAR-FLOW Tränke umzustellen, ist es besser Standardmuttern als unverbrüchliche Muttern zu benutzen (einfachere Montage).

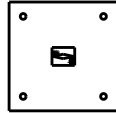
Sachet / sachet / Säckchen**E**

x 1



x 8

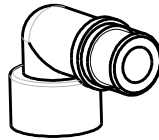

x 4

Sachet / sachet / Säckchen**D**

x 1

Sachet / sachet / Säckchen**G**

x 2.20m



x 1

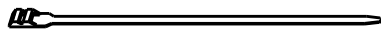

x 2

Sachet / sachet / Säckchen**H**

x 2



x 1



x 25

1

Assemblage de la plaque avec crochets Assembly of plate and hooks Zusammenbau von Platte und Haken

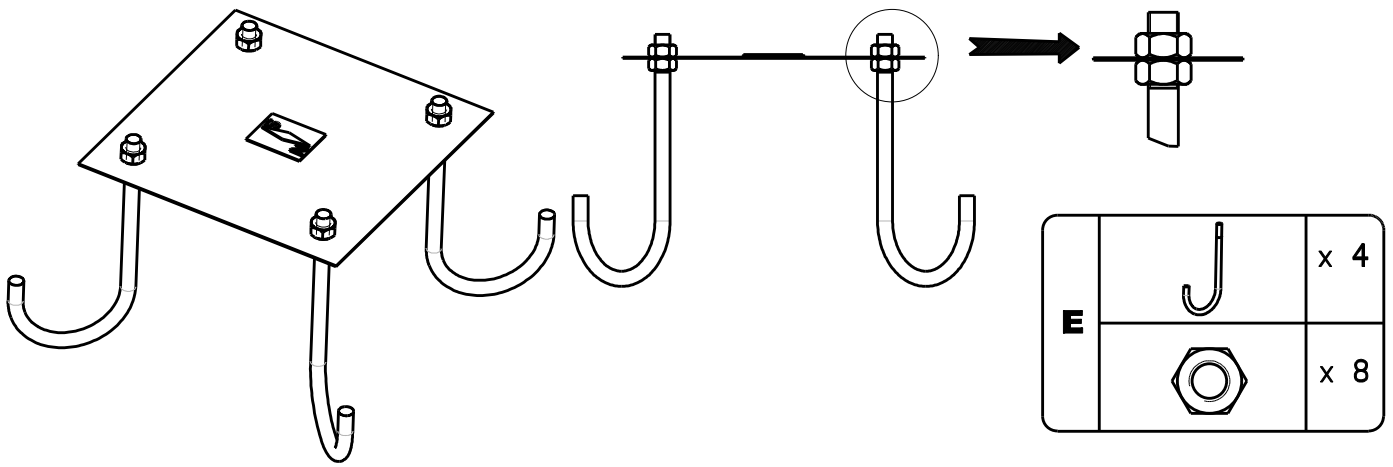

2

Détail du massif et positionnement Schema of the solid mass and positioning Fundamentschema und Positionierung

Plaque avec crochets noyés dans le béton
Plate with hooks sunk in concrete
Platte mit in Beton gegossenen haken

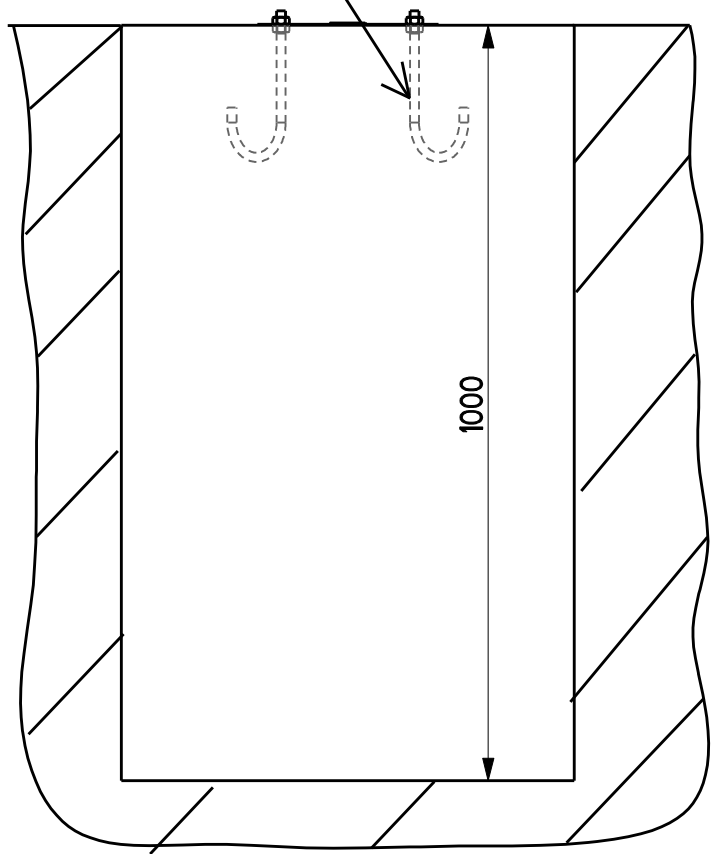

"S" vers le sud
"S" to the south
"S" nach süden

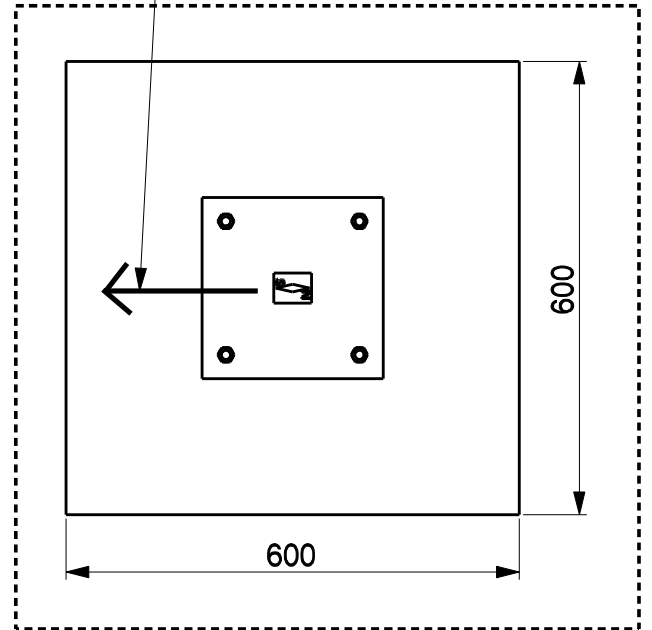

3

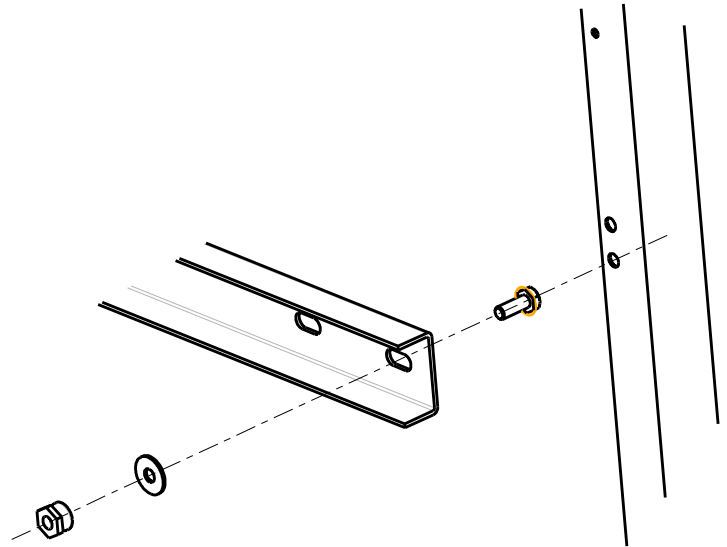
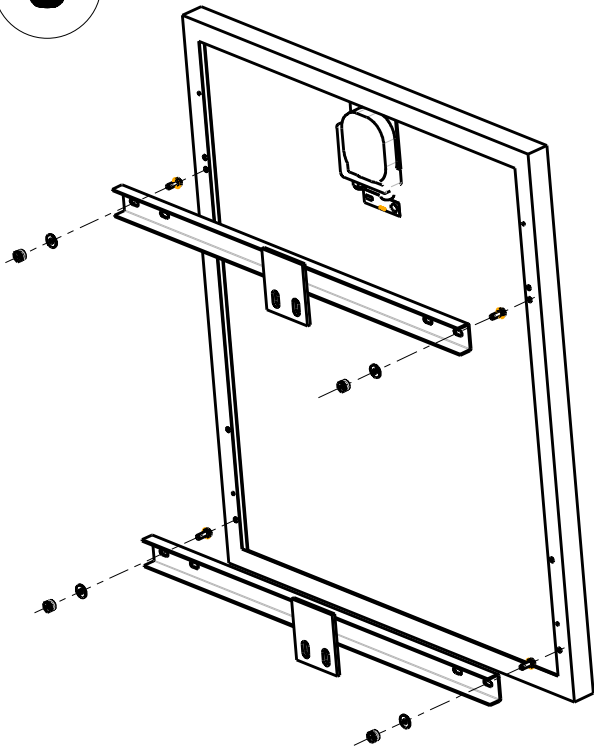

Protéger le panneau durant cette opération
Protect the panel during this operation
Schützen Sie das Panel Während dieser Aktion

A		x4
		x4

4

Serrer fortement l'écrou jusqu'a rupture
(six pans vers l'extérieur)

Tighten hard the nuts up to
breaking (the hexagonal side to the
outside).

Die Mutter Kräftig bis zum
Bruch anziehen
(die Sechskante nach außen).

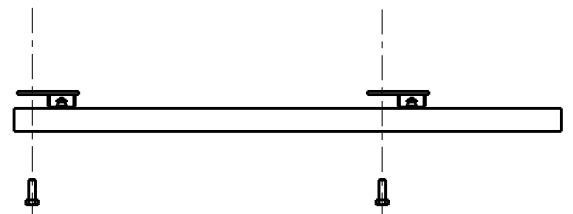
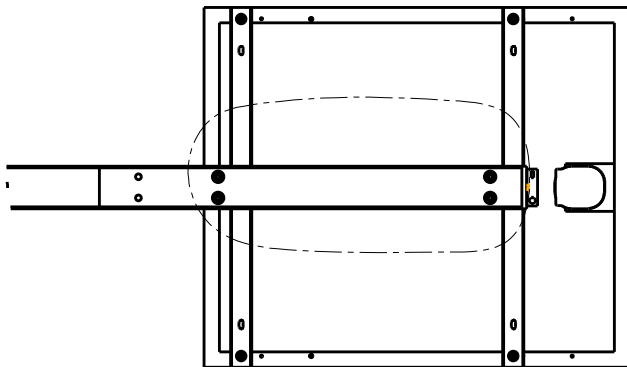
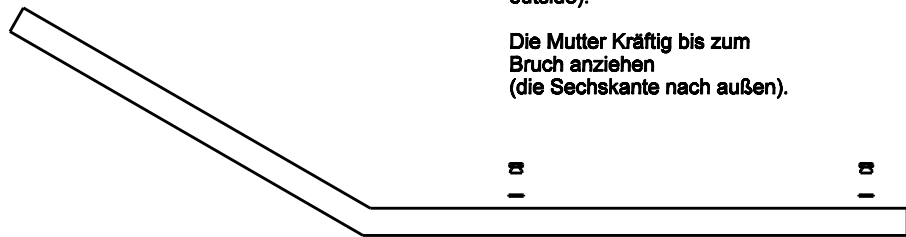

Protéger le panneau durant cette opération
Protect the panel during this operation
Schützen Sie das Panel Während dieser Aktion

F		x4
		x4

5

Passage des câbles "régulateur-panneau" dans le mât
Pass the "controller - panel" cables trough the pole
Das "Panel-Regulierungs"-Kabel durch den Mast ziehen

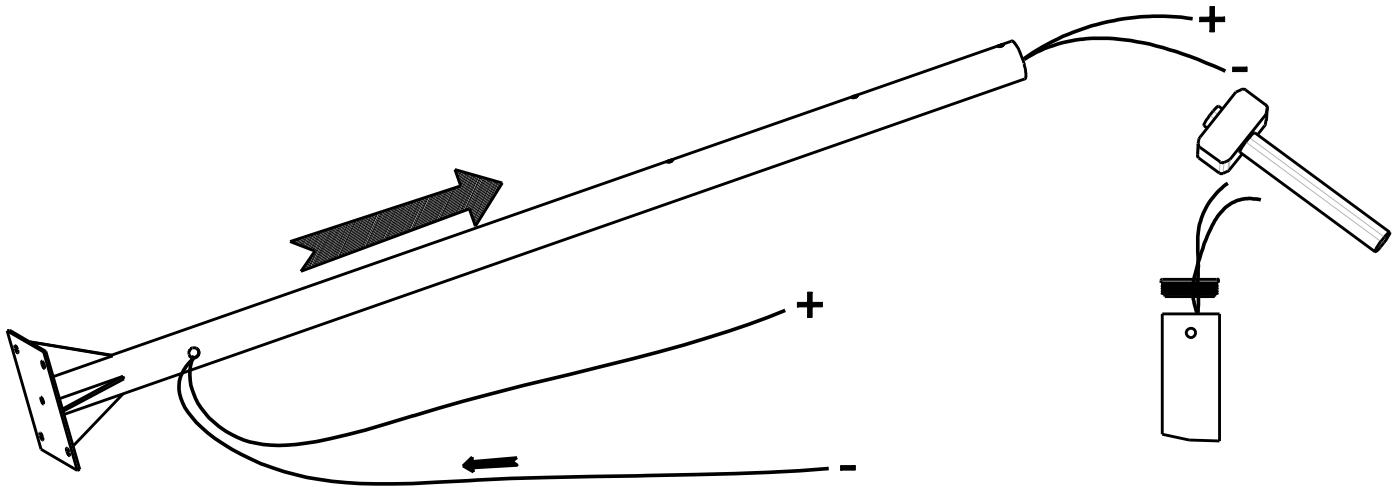

A		x 1
----------	--	-----

6

Serrer fortement l'écrou jusqu'a rupture
(six pans vers l'extérieur)

Tighten hard the nuts up to breaking
(the hexagonal side to the outside).

Die Mutter Kräftig bis zum Bruch anziehen
(die Sechskante nach außen).

écrou inviolable
inviolable nuts
Unverbrüchliche Muttern

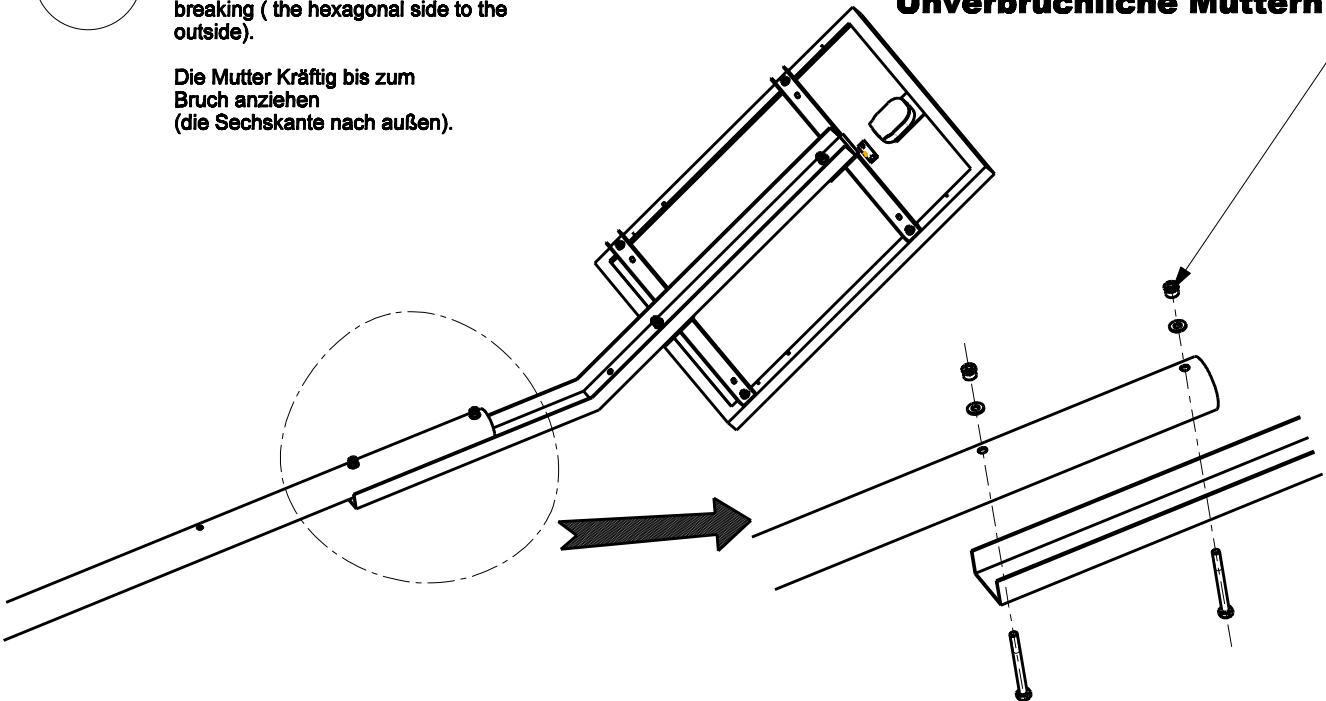

A		x 2
		x 2

7

Branchement du câble sur le panneau Connection of the cable to the panel Anschluss des Kabels auf das Panel

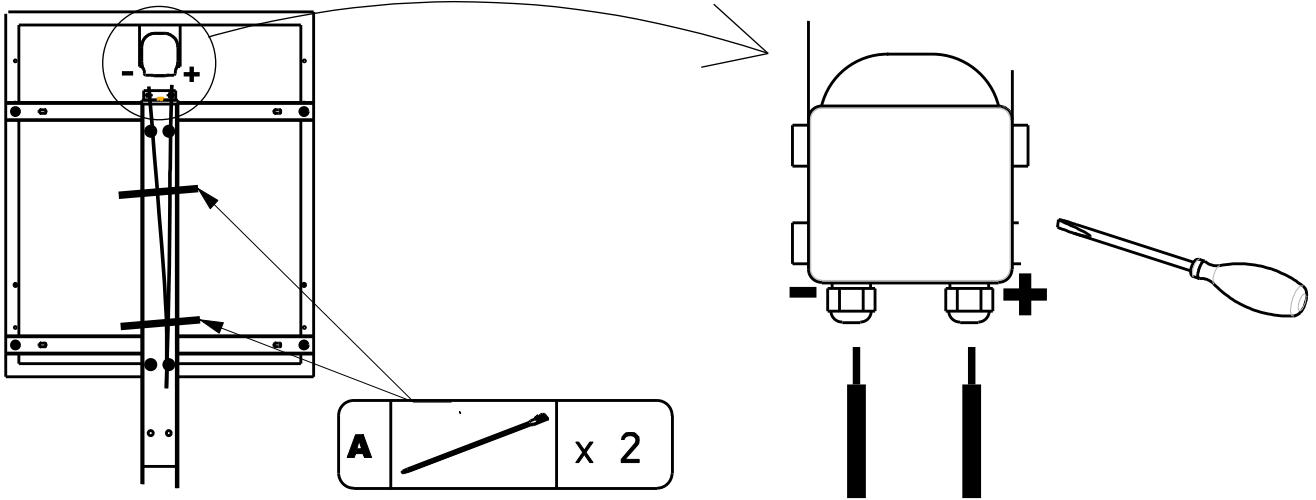

A x 2

8

Fixer le mât au sol Fix the pole on the floor Befestigung des Masts auf dem Boden

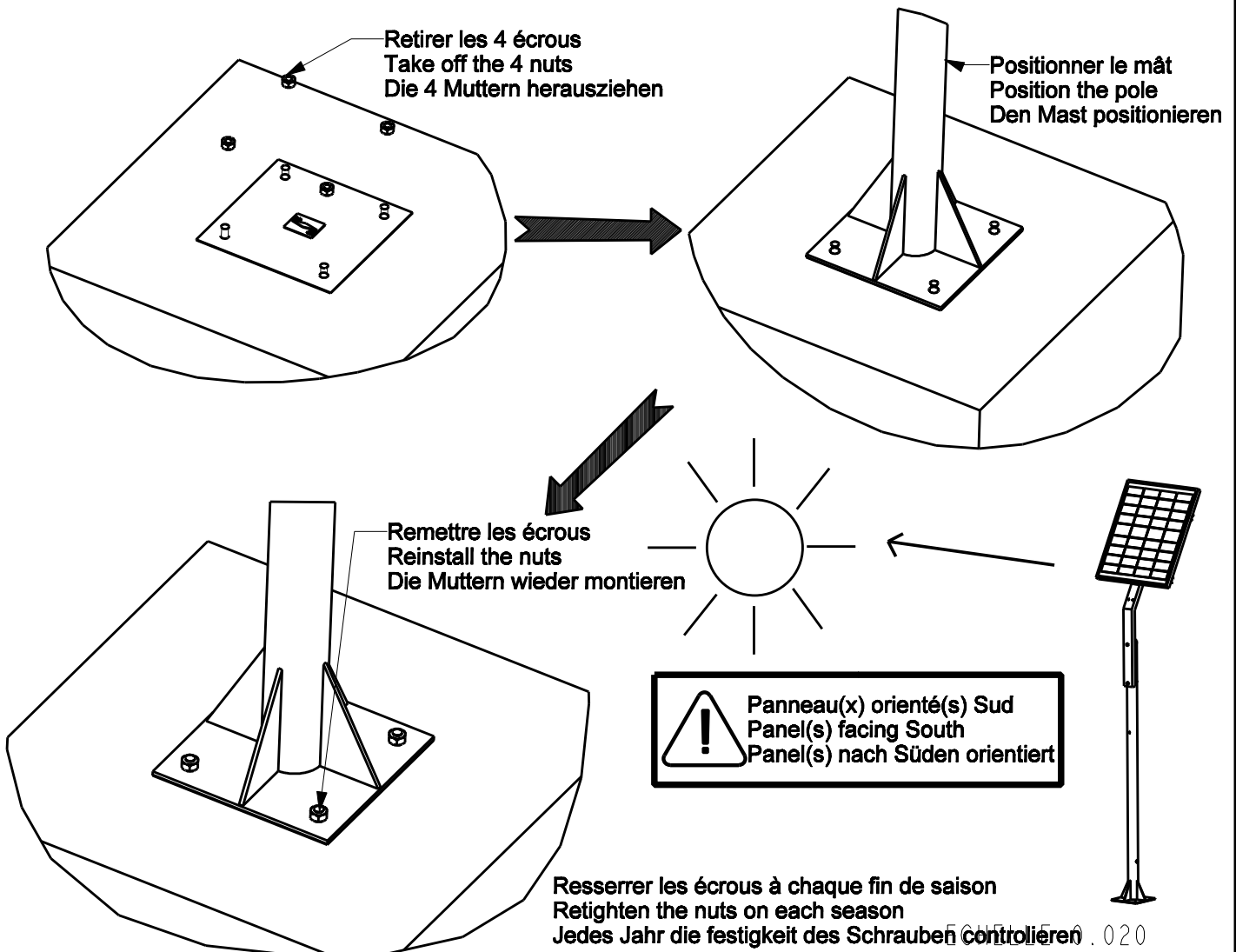

! Panneau(x) orienté(s) Sud
Panel(s) facing South
Panel(s) nach Süden orientiert

Resserrer les écrous à chaque fin de saison
Retighten the nuts on each season
Jedes Jahr die festigkeit des Schrauben kontrollieren . 020

9

Brancher la batterie
Connect the battery
Die Batterie anschließen

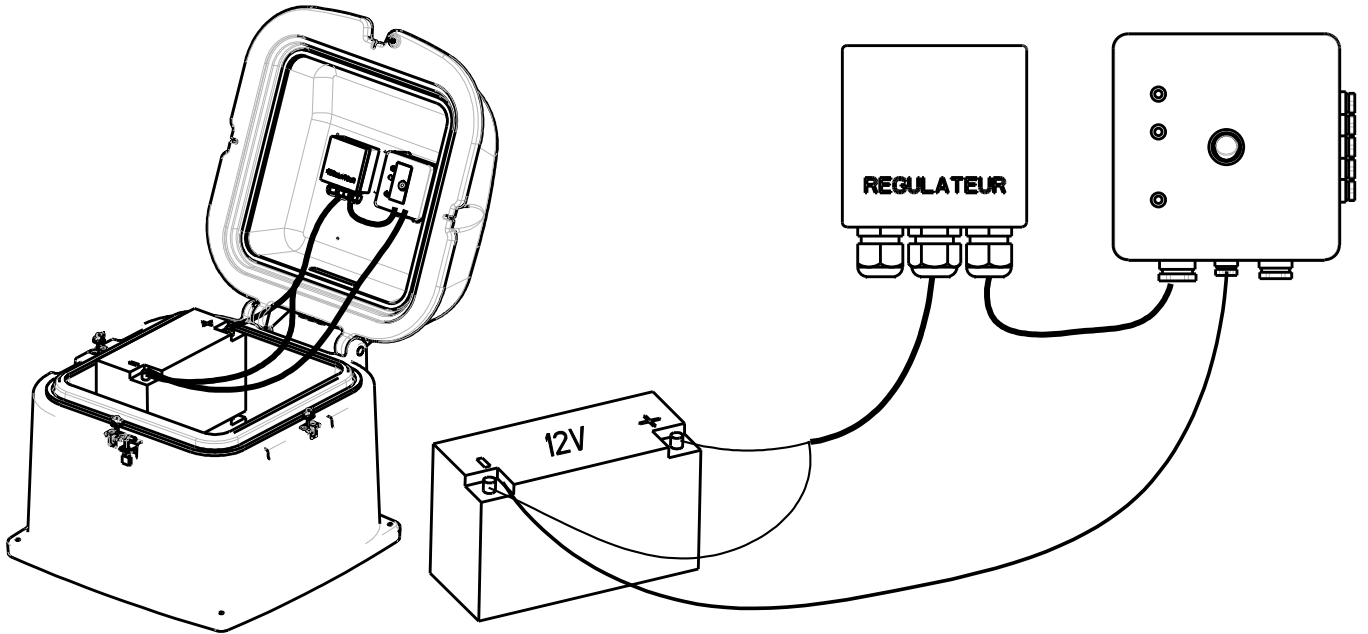

10

Branchement entre régulateur et panneau solaire
Connection between controller and solar panel
Anschluß zwischen Regler und Solarpanel

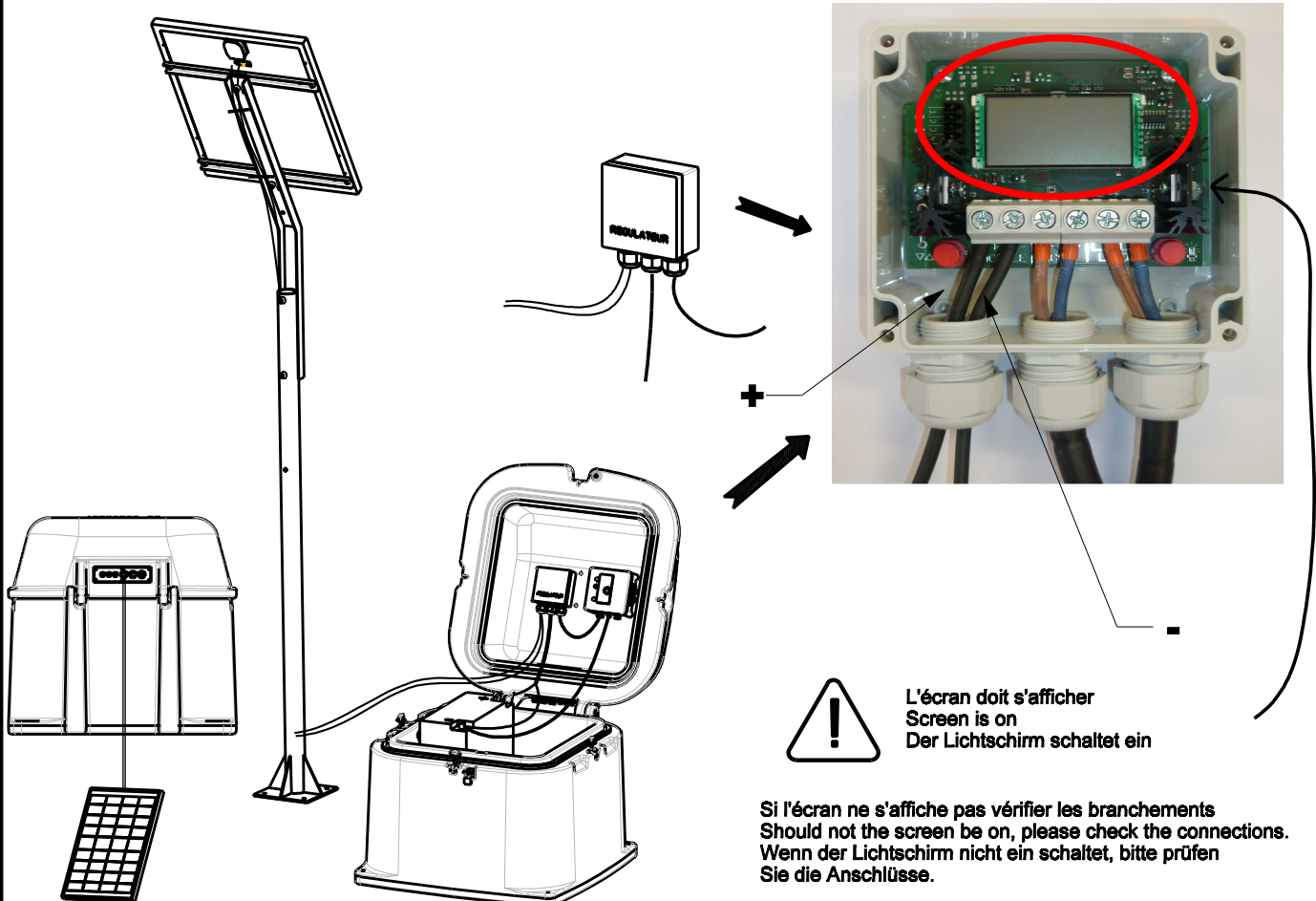

11

Branchement du tuyau souple et du câble électrique à la pompe
Connection of the flexible tube and the electrical cable to the pump
Anschluß des flexiblen Schlauchs und des elektrischen Kabels an die Pumpe

Assembler le tuyau sur le manchon cannelé, puis serrer le collier fourni dans la boîte de la pompe.
 Assemble the waterpipe on the sleeve, then tighten the provided ring in the box of the pump.
 Stecken Sie den Schlauch auf die Muffe, dann die Schelle anziehen, der im Kasten der Pumpe mitgeliefert wird.

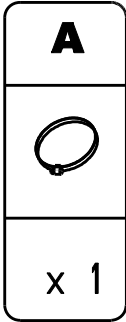
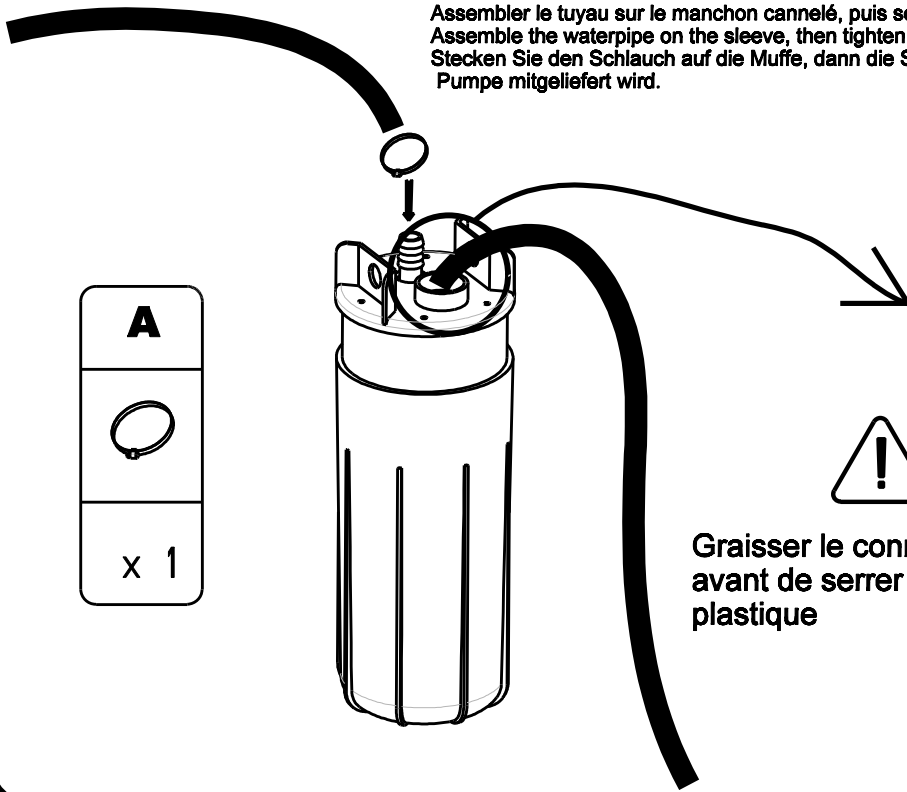

!
 Graisser le connecteur
 avant de serrer l'écrou
 plastique

12

Mise en place du filin sur la pompe
Mounting of the rope on the pump
Den Draht an der Pumpe anbringen

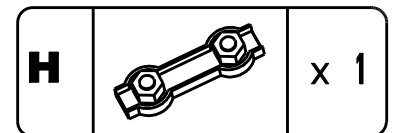
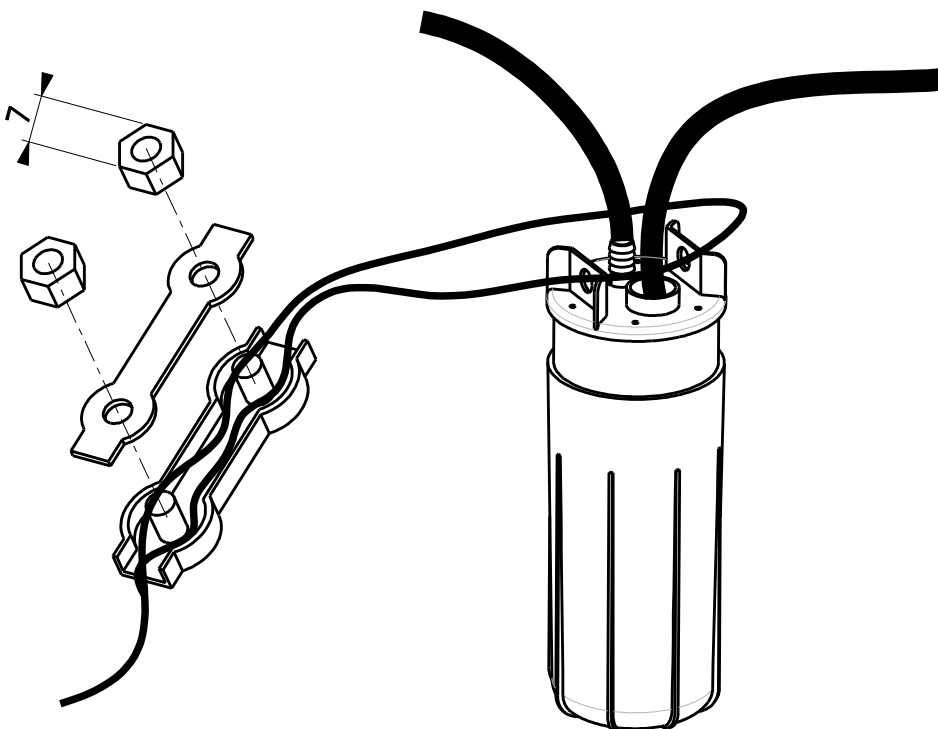

13

Assembler et Accrocher le capteur fond de puits au filin
Assembly and hook the well water level sensor to the rope
Zusammenbau und Aufhängen Tiefbrunnenmelder im Verbindung

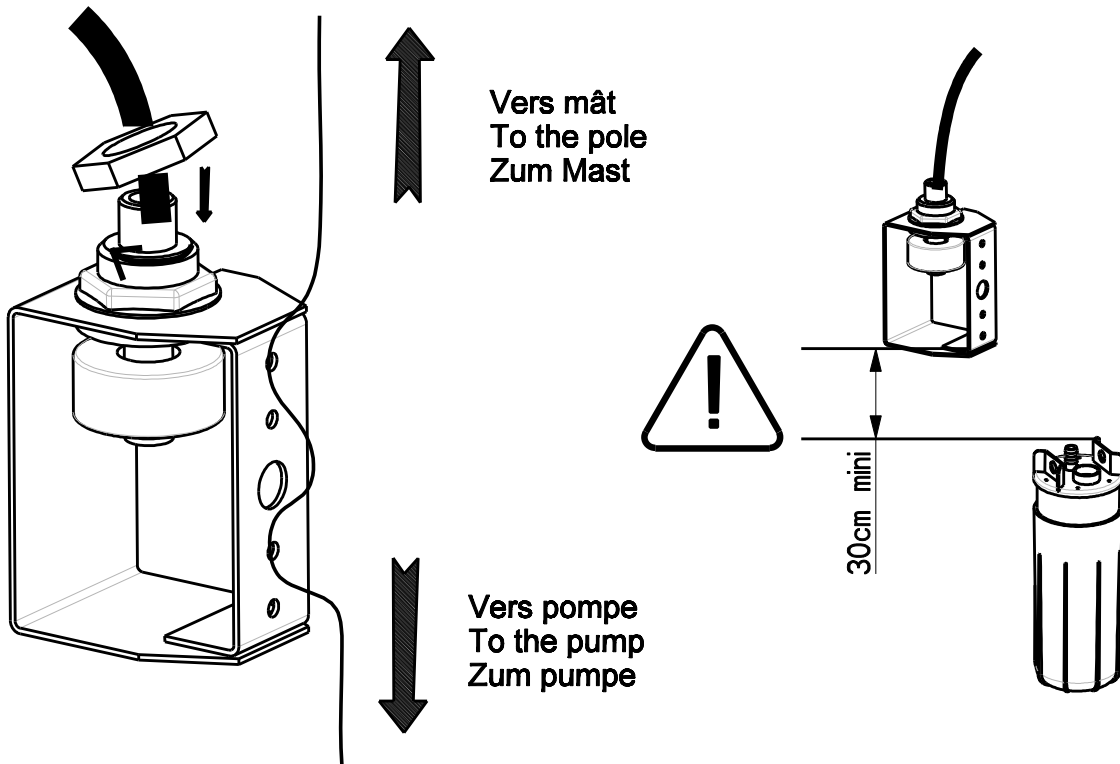

14

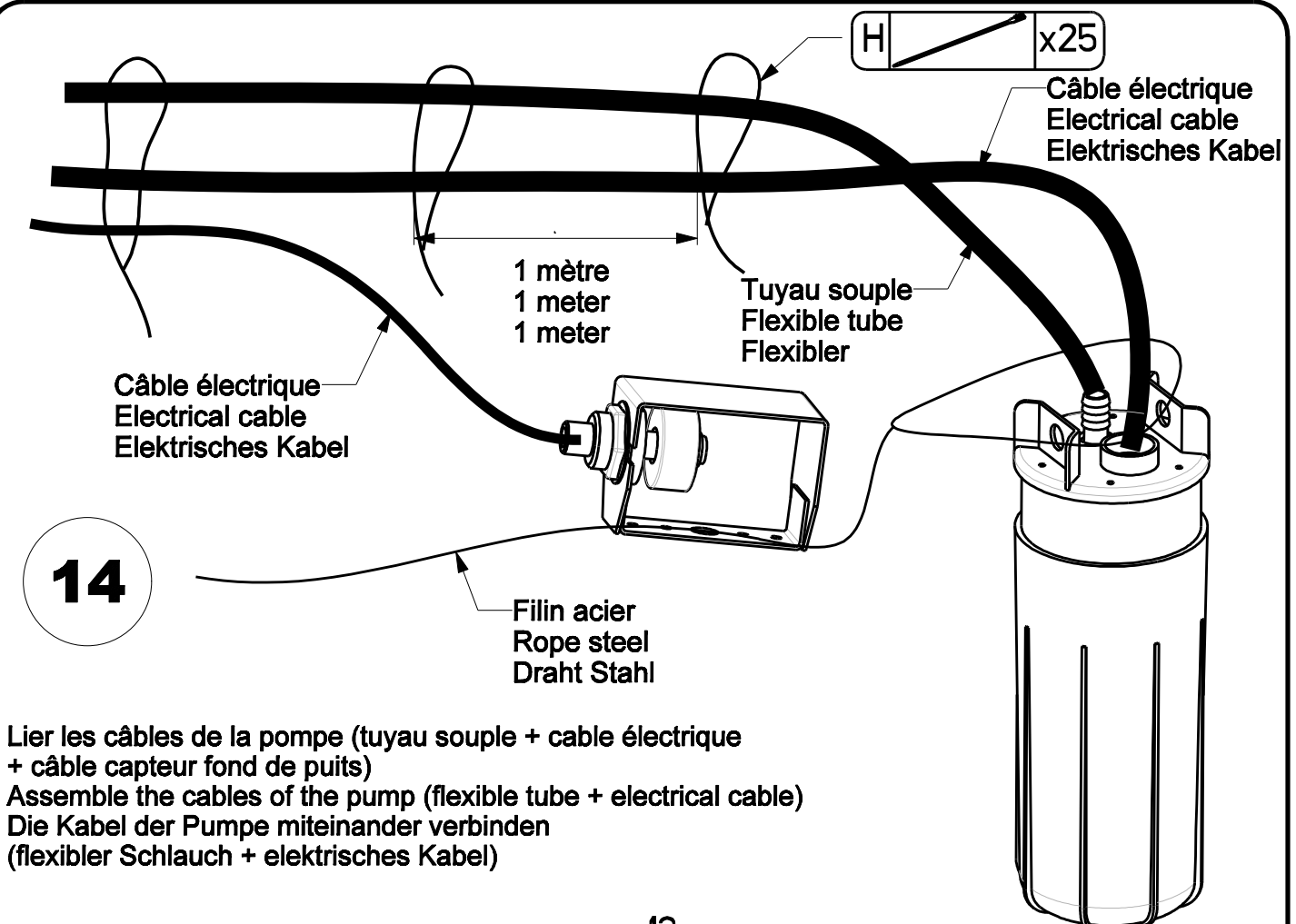

Lier les câbles de la pompe (tuyau souple + câble électrique + câble capteur fond de puits)
Assemble the cables of the pump (flexible tube + electrical cable)
Die Kabel der Pumpe miteinander verbinden
(flexibler Schlauch + elektrisches Kabel)

15

Accrocher le filin à un point fixe
Hook the rope to a fixed point
Den Draht an einen Fixpunkt hängen

Accrocher le filin au mât (par exemple)
 Hook the rope to the pole (for exemple)
 Den Draht zum Beispiel am Mast anbringen

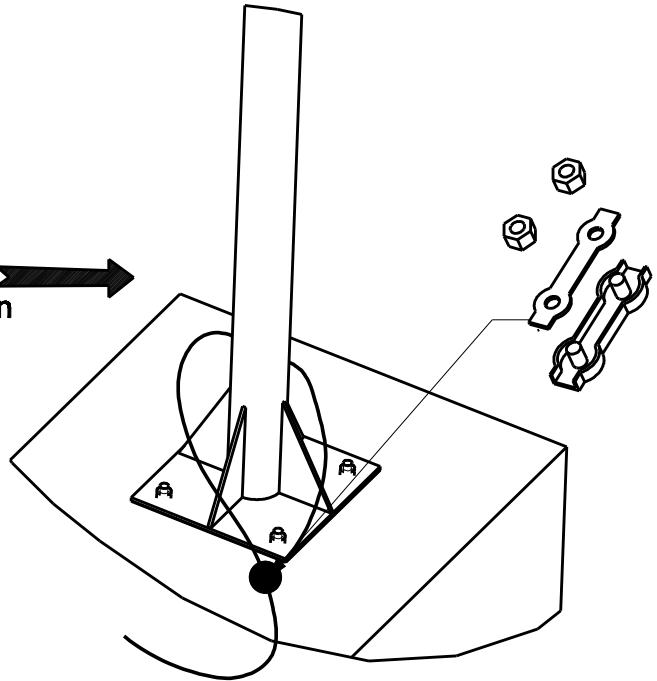
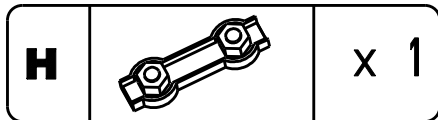
**16**

Branchement de la pompe sur le boîtier électrique
Connection of the pump to the electrical box
Anschluß der Pumpe an den Elektrizitätskasten

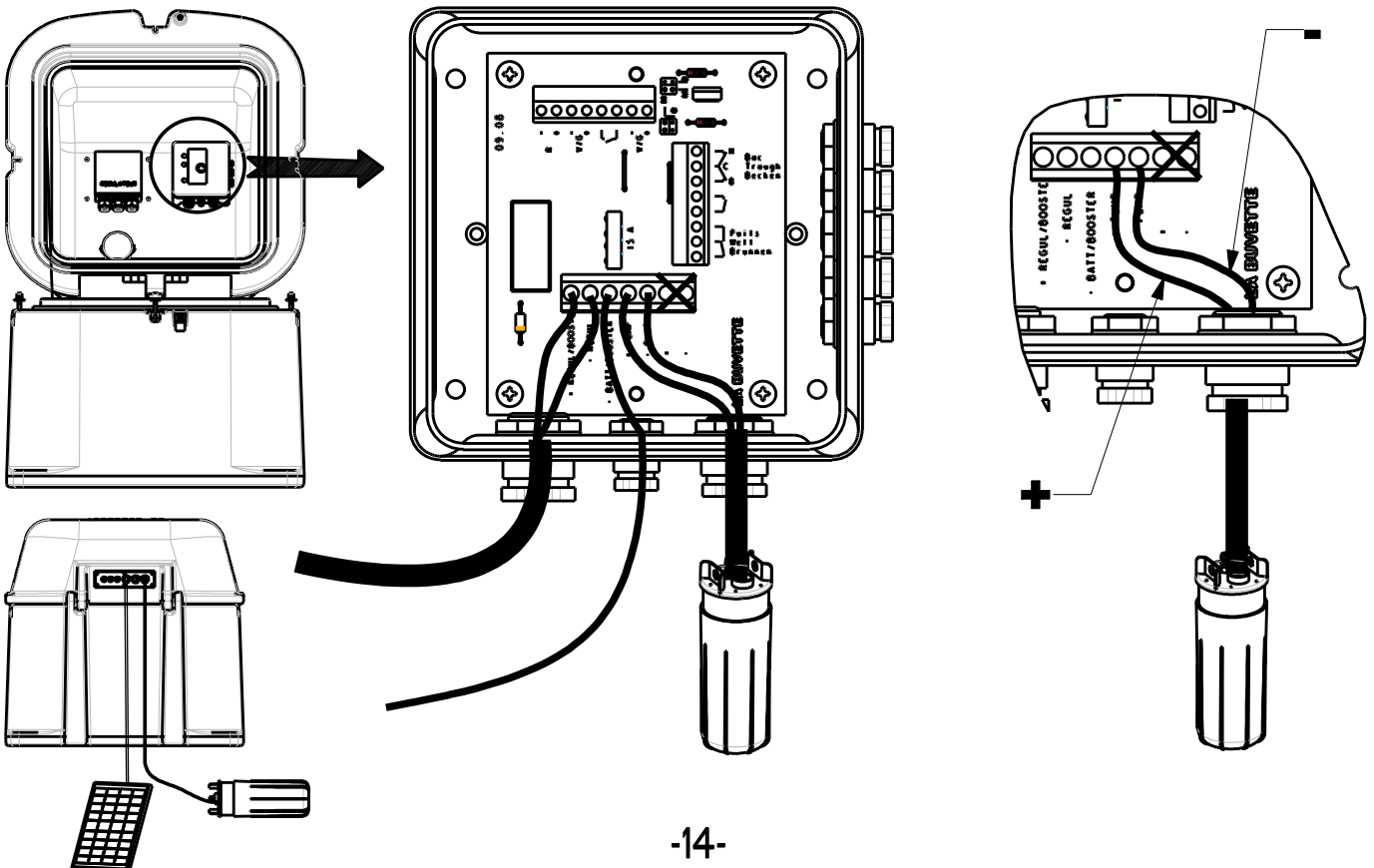

17

Installer les capteur de niveau
Install the level sensor
Die Wasserspiegelsensoren installieren

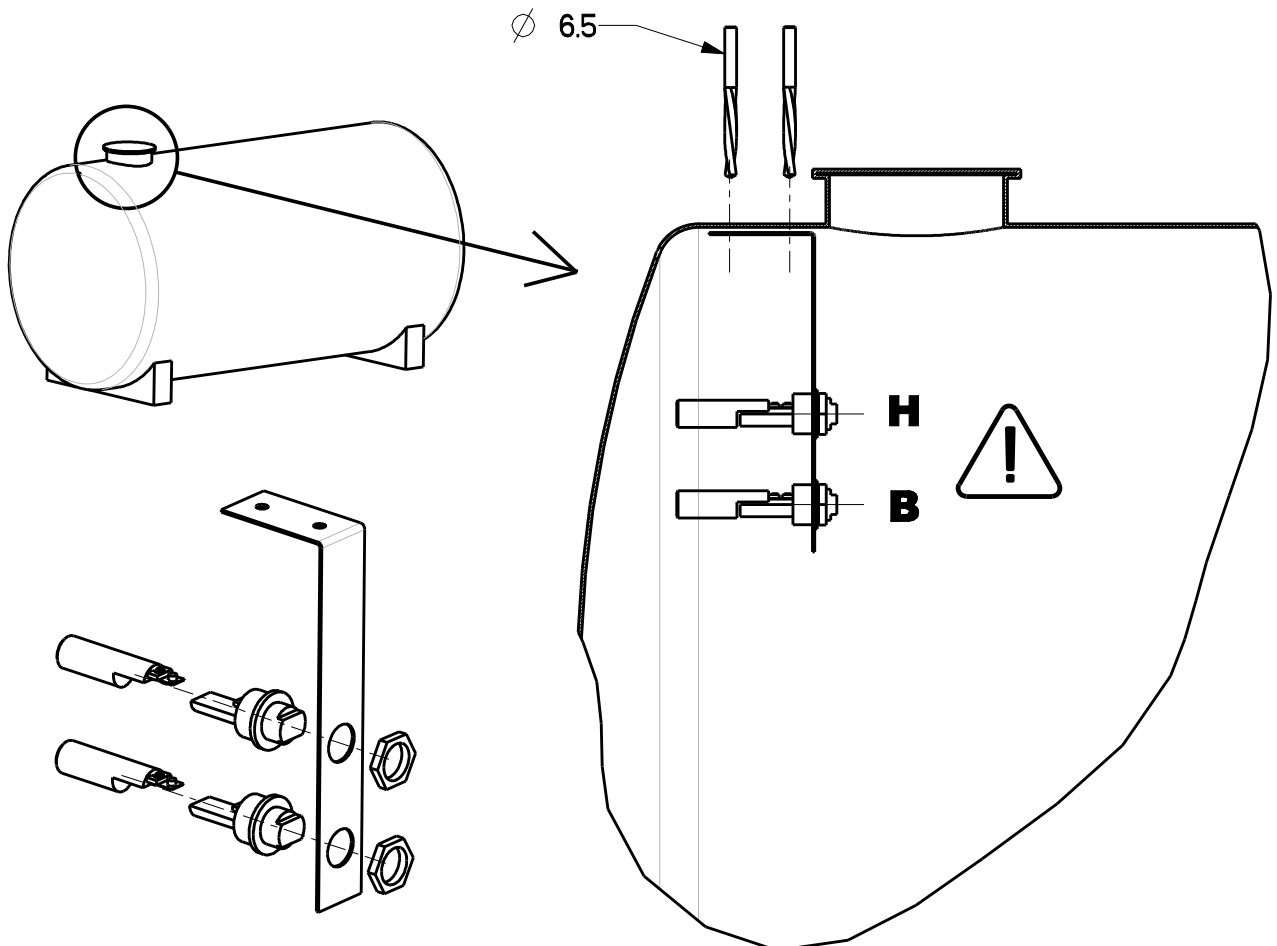
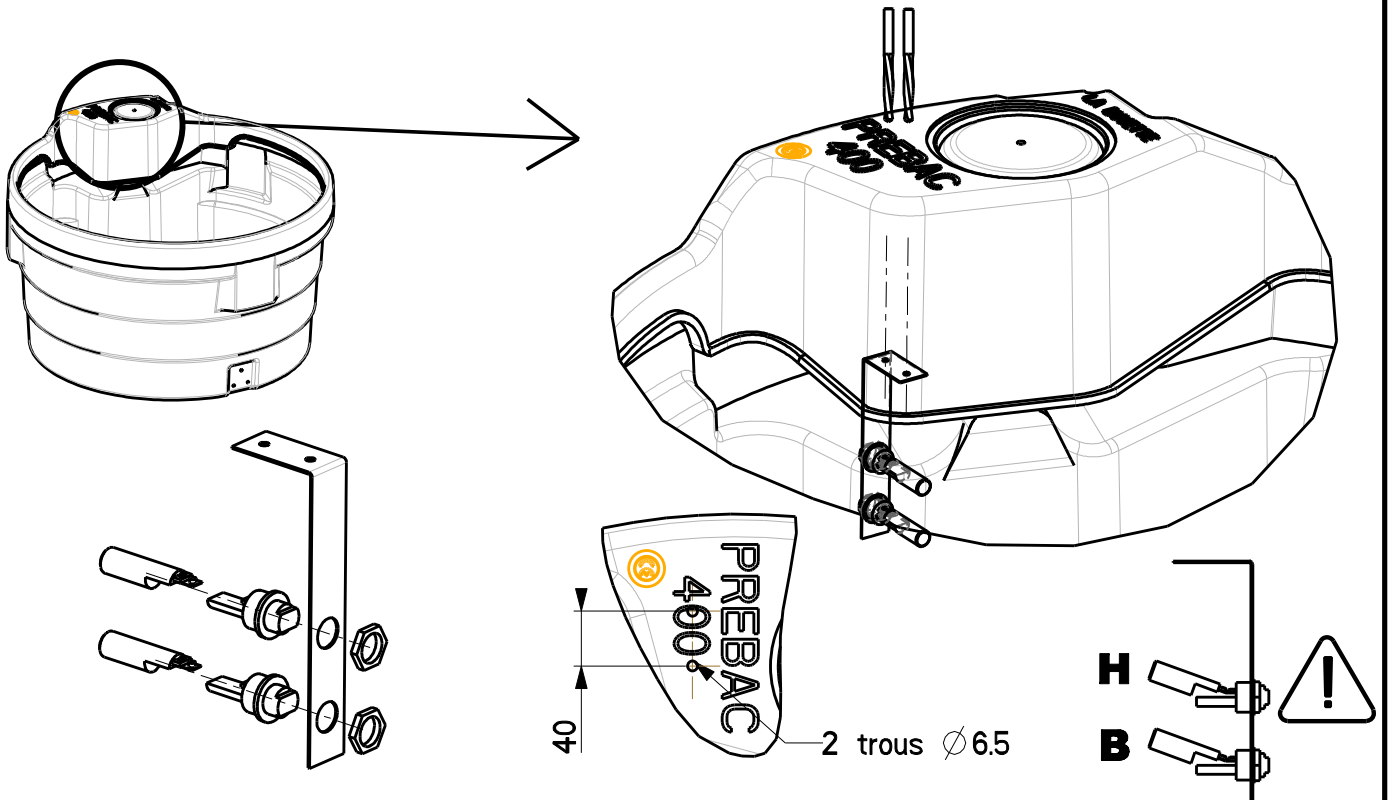

18

Branchement des capteurs sur le boîtier électrique Connection the sensor to the electrical box Anschluss Schleicher an den Elektrizitätskasten

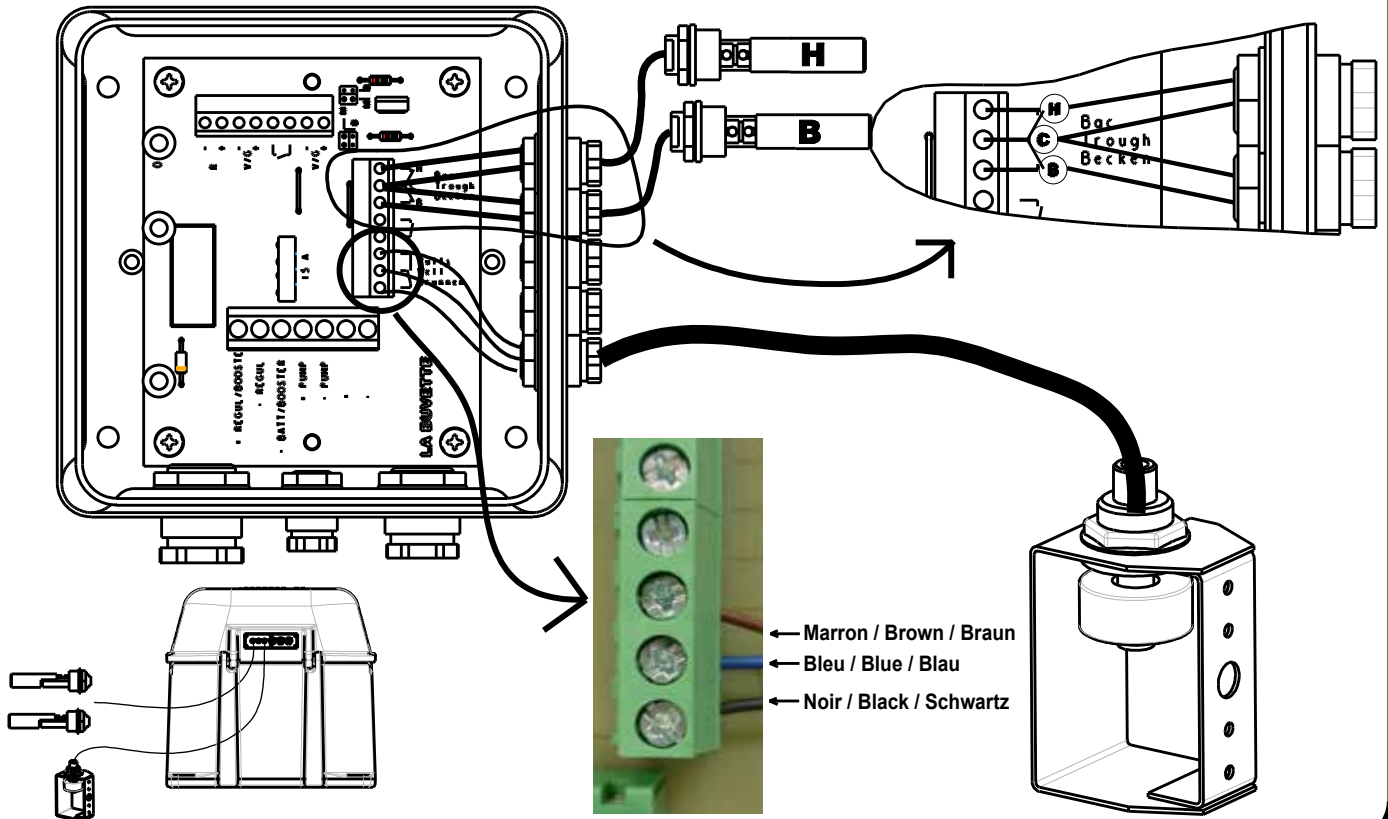

19

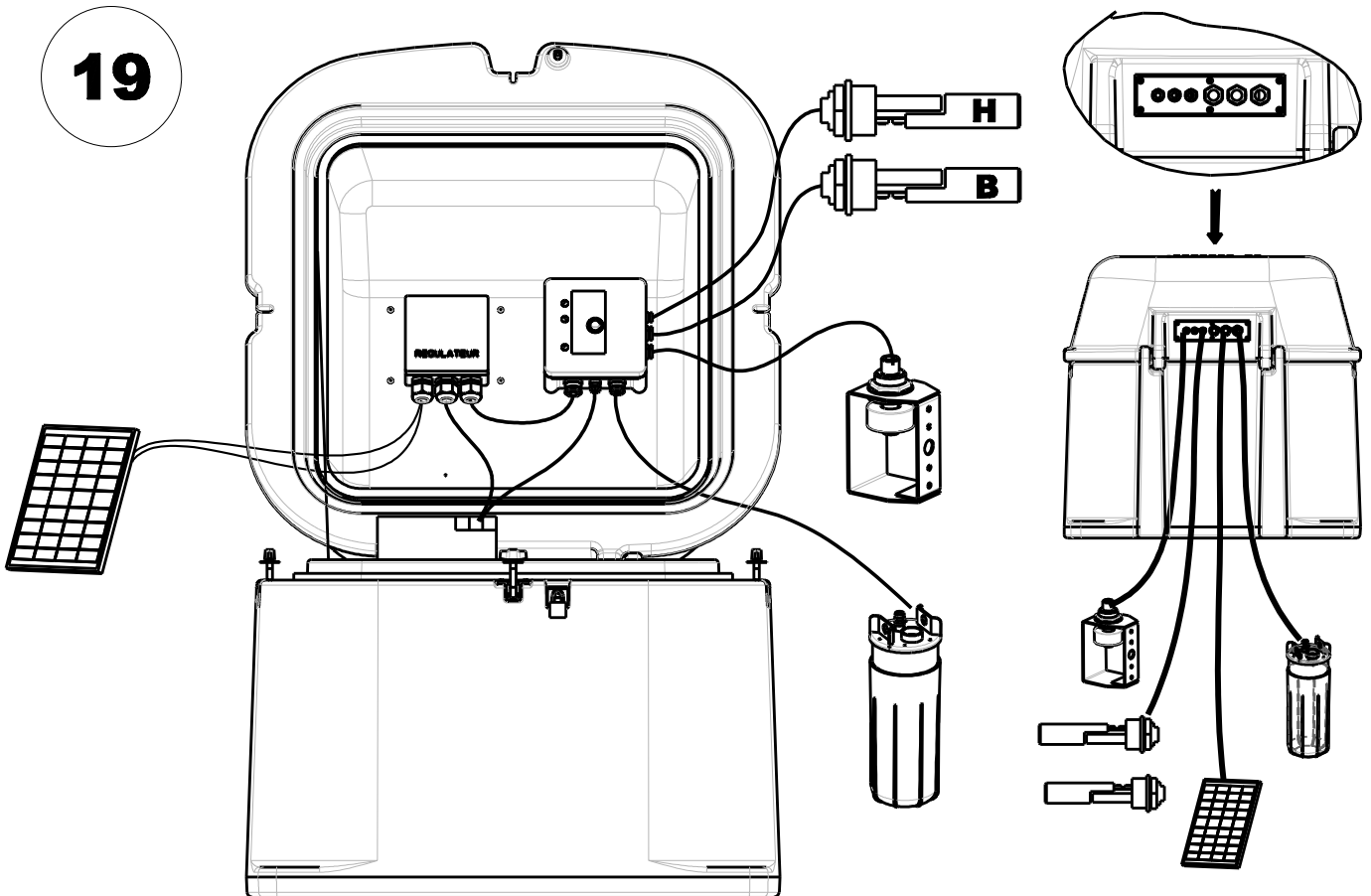







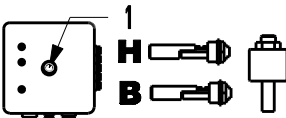

20

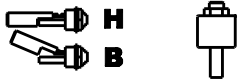
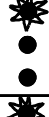
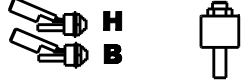
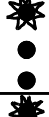
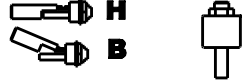
Phase de TEST

Avant immersion de la pompe

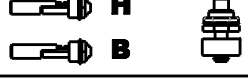
F

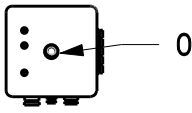









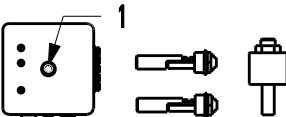

<p>Effectuer les opérations suivantes pour vérifier le bon fonctionnement du système :</p> <p>- Mettre l'interrupteur sur 1 : La pompe doit fonctionner</p>	<p>Vert Rouge Vert</p> 	
<p>- Relever le capteur de niveau B : La pompe doit fonctionner</p>		
<p>- Tout en maintenant levé le capteur B, relever le capteur H : La pompe doit s'arrêter</p>		
<p>- Tout en maintenant levé le capteur B, relacher le capteur H : La pompe doit être arrêtée</p>		
<p>- Relacher le capteur B : La pompe doit fonctionner</p>		
<p>- Lacher le capteur fond de puits : La pompe doit s'arrêter</p>		
<p>- Mettre l'interrupteur sur 0</p> <p>Si les opérations ci-dessus se sont bien déroulées, le montage est OK. Sinon, revoir les connexions électriques et/ou revoir le positionnement des capteurs.</p>		

20







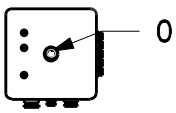





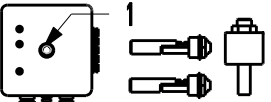



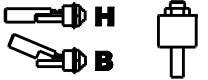



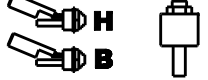



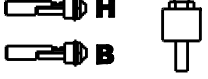

TEST

before immersion of the pump

GB

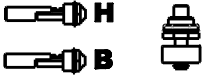
<p>Execute the following operations to check if the system works properly :</p> <p>- Switch on 1 : The pump must work</p>	<p>Green Red Green</p> 	
<p>- Lift up again the sensor level B : The pump must work</p>		
<p>- While keeping the sensor B lifted, lift the sensor H : The pump must stop</p>		
<p>- While keeping the sensor B lifted, loosen the sensor H : The pump must not work</p>		
<p>- Loosen the sensor B : The pump must work</p>		
<p>- Loos the well water level sensor The pump not work</p>		
<p>- Switch off 0 : (3 light switches off)</p> <p>The mounting is OK, if the above operations has been working properly. Otherwise, check the electrical connections and/or check the positioning of the sensors.</p>		

TEST VOR DIE PUMPE EINTAUCHEN

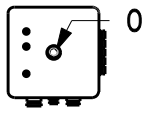
<p>Führen Sie die folgenden Operationen durch, um das einwandfreie Funktionieren des Systems zu überprüfen :</p> <p>- den Schalter 0/1 anschalten : Die Pumpe muss funktionieren</p>	<p>  Grün  Rot  Grün </p>	
<p>- Den Wasserspiegelsensor B hochheben : Die Pumpe muss funktionieren</p>	<p>    </p>	
<p>- Während Sie den Sensor B hochhalten, heben Sie gleichzeitig den Sensor H hoch : Die Pumpe muss anhalten</p>	<p>    </p>	
<p>- Während Sie den Sensor B hochhalten, lassen Sie gleichzeitig den Sensor H los : Die Pumpe muss still stehen</p>	<p>    </p>	
<p>- Lassen Sie den Sensor B los : Die Pumpe muss funktionieren</p>	<p>    </p>	
<p>- Lassen Sie den Tief Bronn Melder los Die Pumpe muss stopper</p>	<p>    </p>	
<p>- Den Schalter 0/1 ausschalten</p> <p>Wenn die obigen Operationen gut verlaufen sind, ist die Montage OK; Wenn nicht, sollten sie die elektrischen Schaltungen und/oder die Positionierung der Sensoren überprüfen.</p>	<p>    </p>	

21

Immerger la pompe Immerse the pump Die Pumpe eintauchen

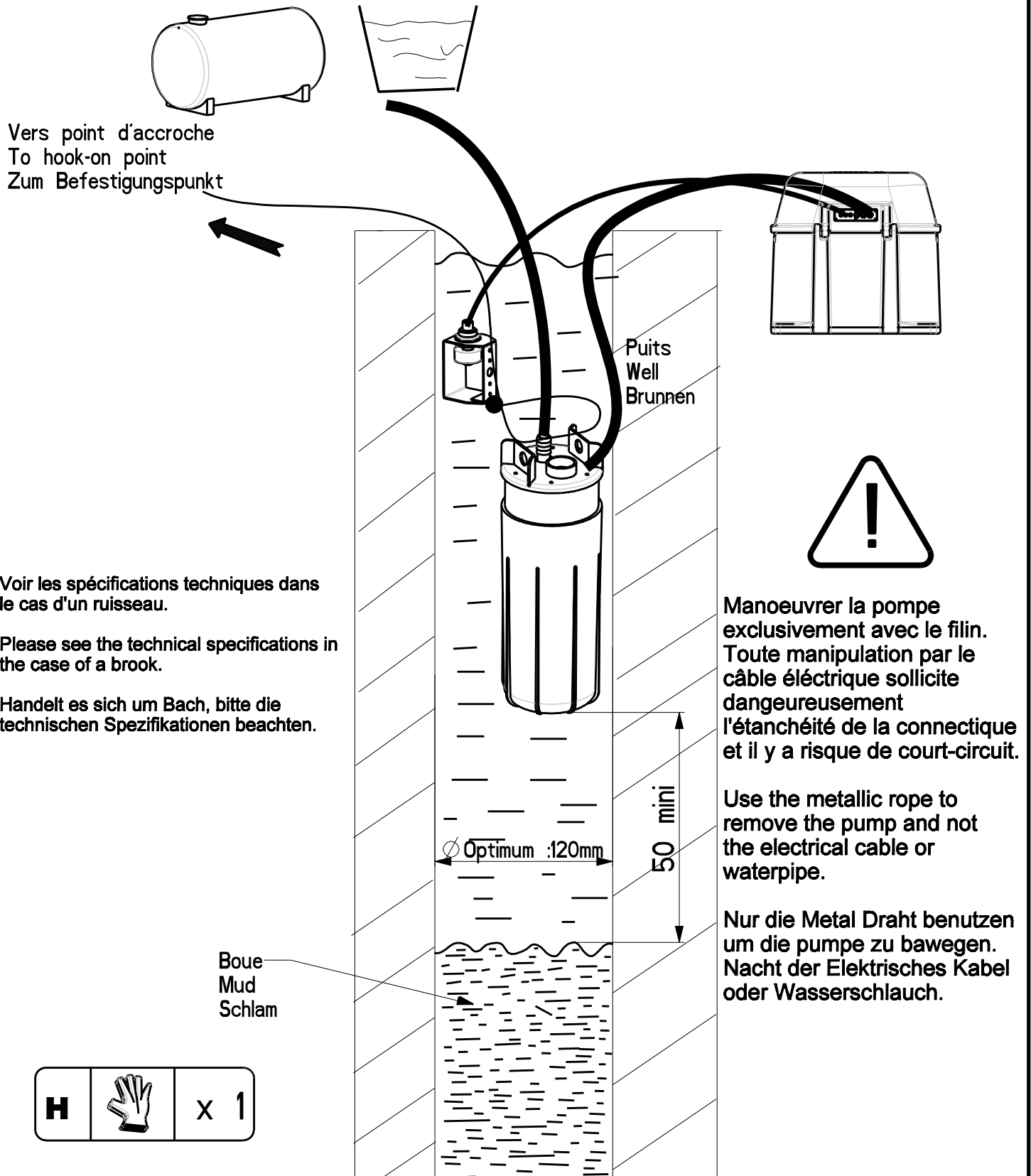

21 a

**Cas d'un ruisseau ou étang /
In case of a brook or a pond /
Im Falle eines Baches oder eines Teichs**

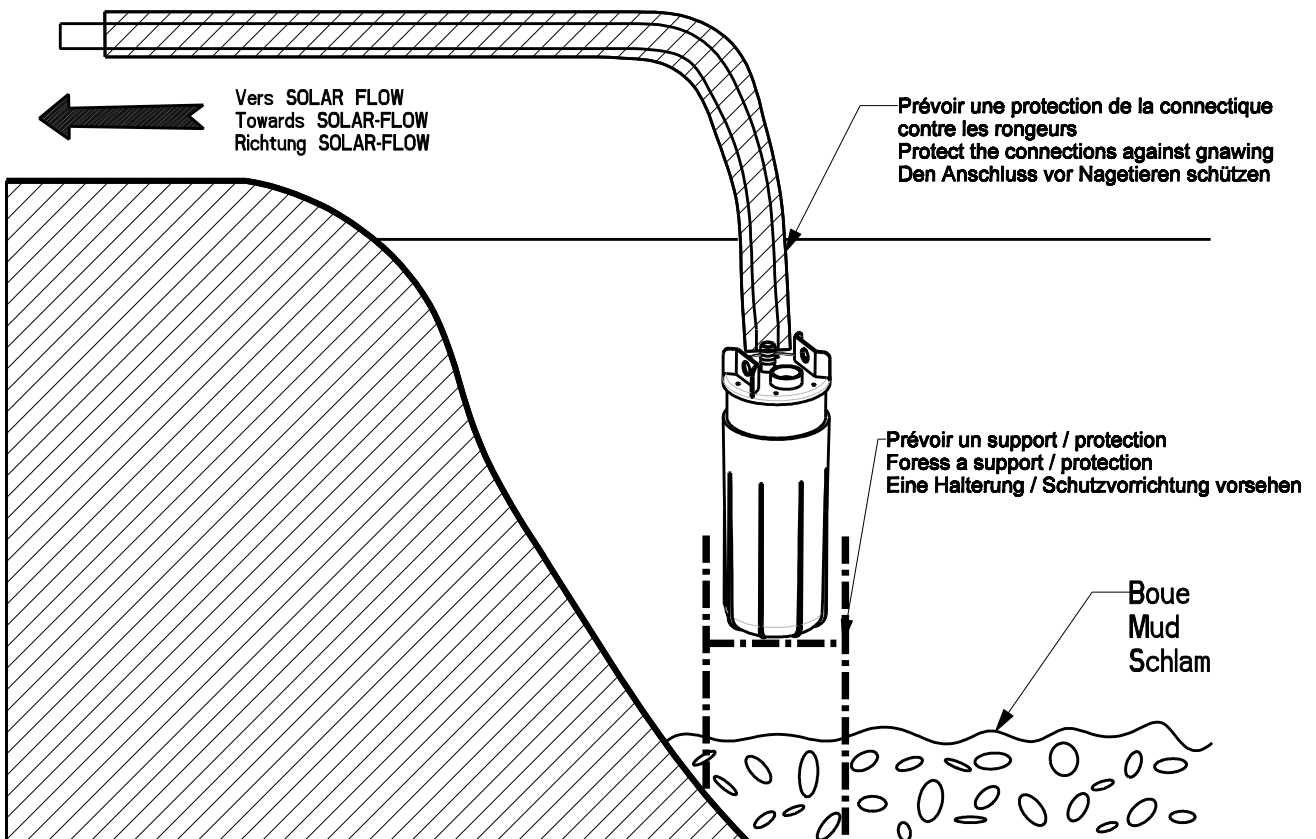
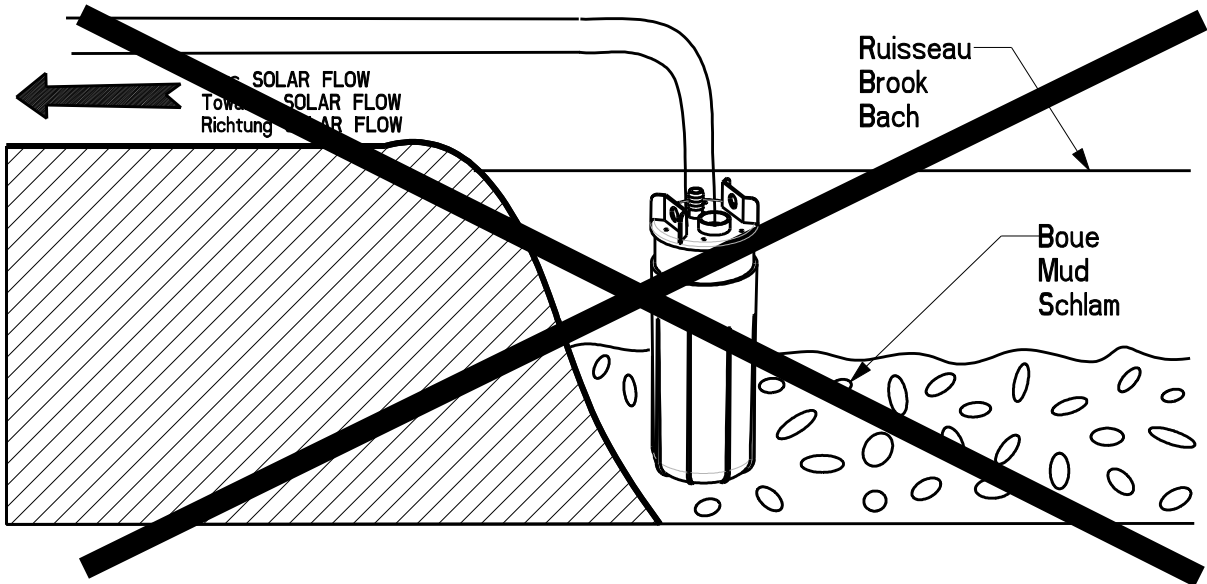

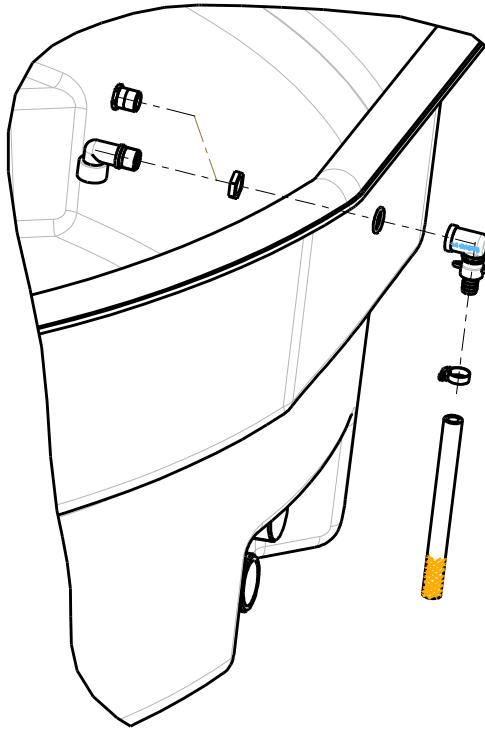
22**Branchement de l'arrivée d'eau sur le bac ou citerne
Connection of the water supply to the trough and tank
Anschluß der Wasserzufuhr auf das Becken oder wasser tank**

ou/
or / oder

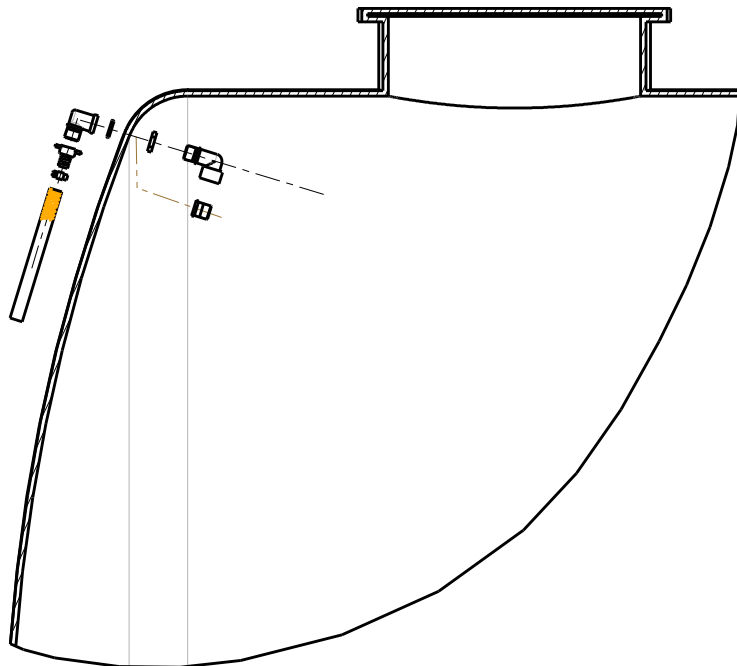
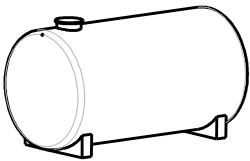

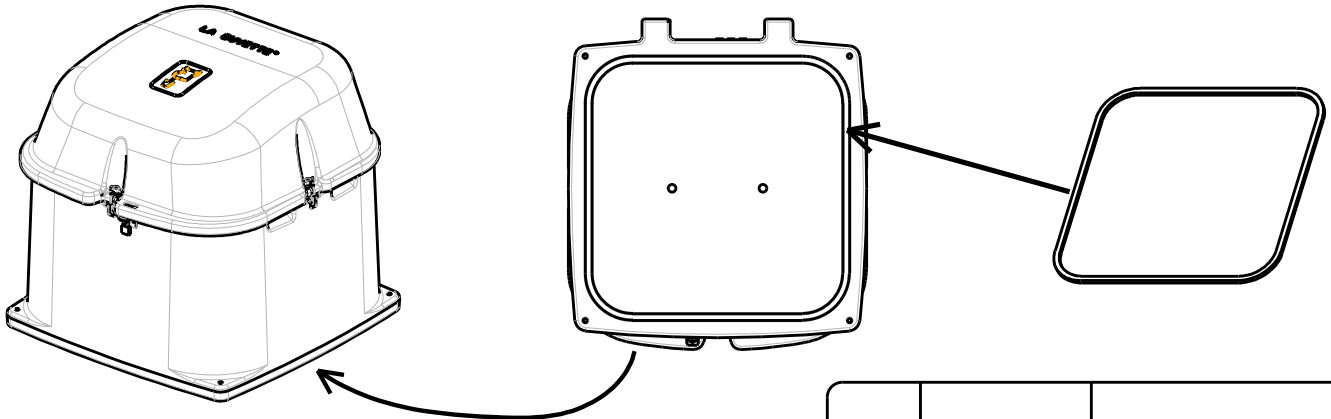

23

Etanchéité et fermeture du coffre
Sealing and locking of the box
Dichtheit und Schließung der Behälter

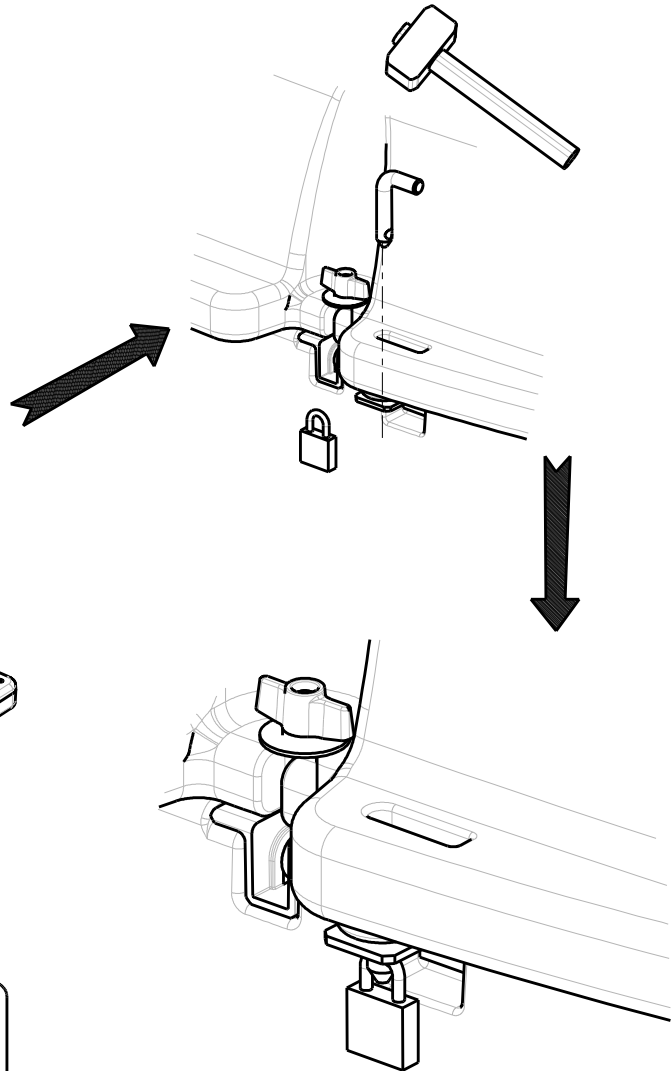
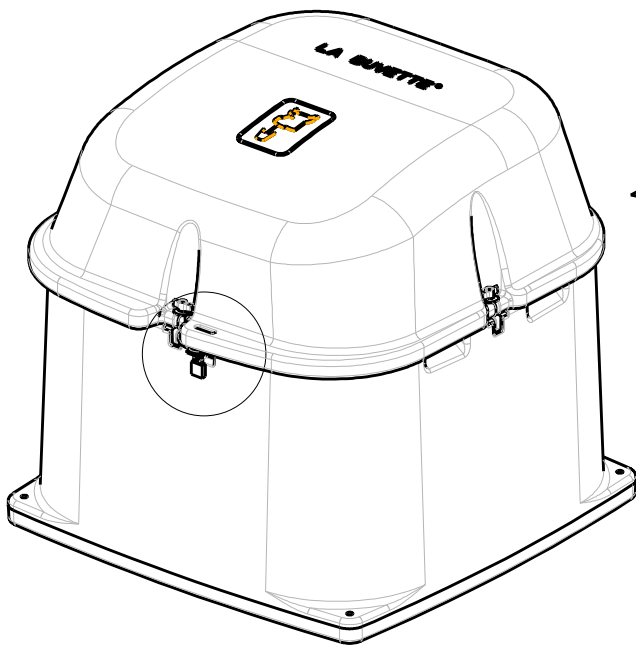

G		x 2.20 m
----------	---	----------



G			x 1
----------	---	---	------------